



SKUTT
GLASS KILNS

OPERATING MANUAL



6441 SE JOHNSON CREEK BLVD. PORTLAND, OR 97206 (503) 774-6000 SKUTT@SKUTT.COM

WWW.GLASSKILNS.COM Revised 3/22/02

Glass Master Operating Manual

KILN SAFETY	4
KILN SETUP	5
Location	5
Unpacking The Kiln	6
Disassembling Multisection Kilns	6
Preparation Before Firing	7
Test Firing	7
THE GLASSMASTER CONTROLLER	8
GLASS FIRE MODE	8
RAMP HOLD MODE	8
PROGRAMMING GLASS FIRE MODE	9
Glass Fire Mode Programming Steps	9
Full Fuse Programs	10
Tack Fusing Programs	10
Slumping Programs	10
PROGRAMMING RAMP AND HOLD MODE	11
Description	11
Ramp and Hold Mode Programming Steps	12
Storing and Recalling programs.	13
16 Segment Programs	13
Skip Step	13
PROGRAMMING FEATURES (KEYS)	14
ANNEAL NOW	14
ADD TIME	14
ADD TEMP	14
BACK	14
CYCLE	14
ENTER	14
MENU	14
REVIEW	14
RECALL	14
START	14
STOP	14
VIEW	14

PROGRAMMING FEATURES (MENU)	14
ALARM (ALAR)	15
DELAY START (DELA)	15
MODIFY GLASS FIRE (MGF)	15
BOARD TEMPERATURE (BD T)	15
LAG TEMPERATURE (LAG)	15
TEMPERATURE SCALE SELECTION (CHG°)	15
16 SEGMENT PROGRAM (16-S)	15
KISS ID (Id)	15
THERMOCOUPLE OFFSET (TCoS)	15
RESET AND GLASS FIRE DEFAULTS (RSET)	15
ERROR CODES ON/OFF (ERCd)	15
DISPLAY MESSAGES	16
GENERAL FIRING GUIDELINES	18
What is a Firing Program?	18
Type of Glass	18
Heatwork	18
Size and Mass	18
Critical Temperature Ranges	19
Firing Processes	20
TROUBLESHOOTING	21
Error Messages	22
WARRANTY & REPAIRS	23
UNIQUE MODEL FEATURES	24
GM10F	24
Using the GM10F	25
Using the GM22CS	26
SPECIFICATIONS	27
WIRING DIAGRAMS	28
PROGRAM TEMPLATE	35
WALL MOUNT TEMPLATE	36

Be Safe

Tens of thousands of kilns are used safely in homes, schools, and professional studios throughout the world. With a good understanding of your kiln and a little common sense you can avoid any accidents. Please observe the following safety recommendations:

- ◆ **The stainless steel jacket and some of the other fixtures surrounding the kiln will get hot enough to burn your skin when the kiln is heated. Therefore it is important to be extremely careful when working close to the kiln.**
- ◆ **Keep small children and pets away from the kiln when it is firing.**
- ◆ **Be careful when opening the kiln door while the kiln is heated. We recommend you use gloves to protect your skin from the hot air that can escape from the chamber of the kiln when opening the lid (or door on frontloading kilns).**
- ◆ **The elements inside the kiln chamber will cause an electrical shock if touched. Never insert metal instruments into the kiln while it is firing. The GM10F was designed with special baffles to protect the operator from a potential shock when inserting mandrels. Never insert mandrels into the kiln chamber if the baffles are removed. The GM22CS is equipped with a switch that temporarily shuts off the power to the elements when the kiln is opened.**
- ◆ **Always be sure to unplug the kiln before working on the electrical components of the kiln.**
- ◆ **Plan on being with the kiln when it is scheduled to turn off.**
- ◆ **Remove all potentially combustible materials from the kiln area.**
- ◆ **Long term viewing inside the kiln chamber can cause damage to your eyes. Therefore, it is recommended that you use IR and UV protective glasses when looking into the kiln for extended periods of time. #3 welders green or gray glasses will protect your eyes.**



Location

1. Locate your kiln near your present electrical outlet or where a new circuit can be installed with the least cost. Position the kiln to the left of your electrical outlet so the cord will have an easy run and will not place a strain on the plug or outlet.
2. Install it in a well ventilated, sheltered area such as a carport, garage, utility or hobby room. It should be convenient to where you are working, and out of the way of traffic areas.
3. Allow at least 18" (46 cm) of space between your kiln and adjacent walls.
4. Do not locate the kiln where flammable materials will be stored.
5. Never fire your kiln within a four sided cabinet or closet. The fourth side must always be open to room air to prevent the kiln from overheating surrounding surfaces. It is best to leave at least two sides open for easy access to controls and peep holes. Fully automatic kilns should not be located in a room that exceeds 105°F (41.5 °C) or is less than 32°F (0°C) as damage to the electronic components may result.
6. The kiln must be placed on a non combustibile surface such as cement, brick, metal or ceramic.
7. When installing a kiln in a room with a fire control sprinkler system, please check the sprinkler head rating to insure that heat emitted from the kiln will not activate the sprinkler system.
8. If you plan on installing an Envirovent system now or in the future. Locate the kilns close to an outside wall so the kiln or kilns can be vented with limited ducting.

Unpacking The Kiln

For Model Specific Setup instructions please consult the Unique Model Features section of the manual.

1. The kiln stand will ship in a separate box on some models. GM10F kilns are designed with a built in kiln stand.
2. Remove the black plastic stand feet from the accessory bag and place them on the stand legs. Set the stand in the location you have designated for the kiln. Be sure to remove peep plugs that may be taped to the stand.
3. For GM1227, GM1018, and GM818 models you may choose to disassemble the kiln into smaller components before moving it from the box. *See Disassembling Production Series Kilns.*
4. With a partner, lift the kiln, using the lower section handles (on models with handles), and rest on a clean, flat surface. The floor of the kiln is not attached to the bottom section on top loading kiln models.
5. Position the kiln floor on top of the stand making certain that the weight is evenly distributed.
6. Level the kiln. Make sure the stand and kiln floor are level and do not teeter. Leveling problems may put unnecessary stress on the kiln during firing. To level the stand, place firm shims under the legs (never above them touching the kiln). Center the kiln's bottom slab on the stand and double-check teetering. On the GM10F the stand is built into the design of the kiln.
7. With a partner, pick the kiln up and rest it on top of the kiln floor.
8. In kilns with peep holes, place the plugs in the hole or holes. (*Peep holes are holes in the side of the kiln used for viewing inside the kiln chamber and for venting gases.*)
9. If the unit has a wall mounted controller consult the instructions on page 26.
10. Plug the kiln into the wall receptacle and you are ready to test fire the kiln. When the kiln is plugged in, the display reads PF. Press Enter and the kiln should enter **IDLE Mode**. If there is no display consult the troubleshooting section of this manual.



DISASSEMBLING MULTISECTION KILNS (ALWAYS UNPLUG A KILN BEFORE DISASSEMBLY)

1. Remove Lid (**It is not recommended to remove lids with elements in the lid since they are connected electrically**)
 - a. Remove one of the cotter pins from the lid rod and slide the lid rod out of the lid hinge assembly.
 - b. Remove the thumbscrew and lid brace.
 - c. Lift the lid straight up and place lid on a clean, flat surface.
2. Remove Control Box
 - a. Remove the screws on the left side of the box that secure the box to the kiln, and swing the panel to the side.
 - b. Slide the numbered feeder wires and thermocouple wires off of the terminal strip.
 - c. Lift the control box up to remove it from the hinges.
3. Separate Sections
 - a. Unbuckle the draw-pull catches between each section.
 - b. Lift each section using the section handles and place on a flat clean surface.

Preparation Before Firing

Remove any brick chips or other foreign matter from around the elements. Contaminants will eat through the elements. We recommend that you vacuum the inside of the kiln to remove any dust that accumulates during shipment.

You will want to apply a shelf primer, also referred to as kiln wash, on your shelves to protect them from melted glass adhering to them. There are a number of different formulations with different instructions for application so be sure to follow the directions of the brand you choose.

You may also wish to coat the floor of the kiln. **Never kiln wash the walls or lid of your kiln!**

Seating The Elements

The elements of your kiln need to be properly seated into the grooves of the brick. Elements have stress in them much like glass before it is annealed. This stress is caused by winding a stretching the elements. By bringing the elements up to a minimum temperature we can allow the elements to settle into the grooves and relieve this stress. After the elements have been seated, the element is more stable and less likely to pop or crawl out of the grooves.

The controller should be pre-programmed to run the seating program in Ramp and Hold Mode, program #6. Press review to verify that the program listed below is entered in the controllers memory. If the program matches the one below simply press START and let the program run. If for some reason the program is not loaded, please follow the instructions for programming a Ramp and Hold program in the manual.

Program - 6

Segments - 1

Heating Rate 1 - 9999

Temperature - 1650 F

Alarm - 9999

Test Firing

The test fire insures you that the kiln is functioning properly and has not been damaged in shipping. Be sure that the coating on the shelves is dry before your first test fire.

TEST FIRE PROCEDURE

- Post up a shelf in the kiln chamber at a level where the top of the shelf is between 1” and 2 “ below the thermocouple. Fuse with the shelf in this position relative to the thermocouple whenever possible for accurate and consistent results.
- Place a sample glass project using scrap fusible glass in the kiln and choose a GlassFire mode program using the instructions on page 9. As a precaution you may want to provide a dam or barrier around the glass when fusing more than 2 layers. With more than 2 layers, the glass will spread until it finds a level of 1/4”.
- Let the kiln fire and then cool to room temperature before opening the lid. If the project is fused or slumped to your satisfaction the kiln is operating correctly.

The first time the elements are fired they will give off some smoke. This is normal and expected. It is also common for hairline cracks to appear in the floor of a kiln. This is caused by the expansion and contraction of the mortared brick and is considered normal. It will not affect the firing of your kiln nor the life of the kiln floor.

The key layout on the GlassMaster is designed to be easy to understand and efficient. Multifunction keys allow you to load and review saved programs with a minimum amount of key strokes.

Adjustments can be made even during the firing without interruption. Beginners and professionals alike will appreciate the logical design of the layout. There are two programming modes available on the GlassMaster.

LED Display

MENU allows access to advanced programming features.

If an error is made the programmer can press **BACK** to input the correct data.

The **Anneal** key is pressed when the glass has attained the desired heatwork and the artist wishes to begin the annealing process.

Add Time key adds time to the final heating segment in increments of 5 minutes during the firing.

Add Temp adds 5 degrees F of heat to the final heating segment.

The **View** key will display the current segment of the firing program.

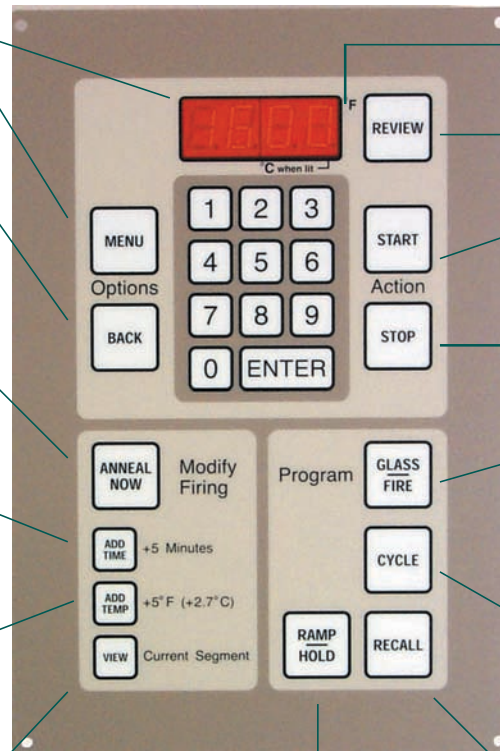

Temperature Scale Selection

key allows you to change from Fahrenheit to Celsius.

The **Review** key displays the program that is currently loaded.

The **Start** key begins the program.

The **Stop** key will stop the program at any point in the firing.

The **Glass Fire** key accesses preset fusing, slumping, and tack fusing programs with choices of varying firing speeds.

The **Cycle** key is used in conjunction with the Glass Fire key to choose various options.

Ramp Hold allows the artist to construct and store their own specialized firing programs.

For quick access to stored Ramp Hold programs simply press the **Recall** key.

GLASS FIRE MODE

The Glass Fire Mode allows you to access factory installed programs designed for general fusing, slumping, and tack fusing. These programs were designed incorporating general heating and annealing principals. While they will not work for all projects, they are definitely a good place for beginners to start.

The Glass Fire Mode allows you to choose from 3 different firing speeds based on the size of your projects. These speeds are then correlated to the process selected and an annealing program.

RAMP HOLD MODE

The Ramp Hold Mode allows you to design and store your own programs for specialized projects. You can use up to 8 segments (16 segments when programs are linked) which consist of a temperature, a heating or cooling rate, and a hold time if one is desired. You can store up to 6 of your programs for easy recall.

The **Add Time**, **Add Temp**, and **Anneal** features allow you to control the final segment of the heating phase so the kiln begins annealing when you want it to.

The **View** key allows you to check the current segment. The LED constantly displays the temperature and hold times throughout the firing.

The **Menu** key allows the user to program Delayed Starts, Temperature Alarms and many other advanced features.

Please read the Kiln Safety and General Firing Guidelines before programming your kiln.

The **GlassMaster Firing Mode** was designed to give beginners a starting point for their Fusing, Tack Fusing, and Slumping Projects. Using information from glass artists and manufacturers we developed preset firing programs based on the size of the piece and the type of process desired. There are many other variables that can effect the success of a firing project such as position in the kiln, accuracy of the thermocouple, strength of the elements and many others that relate to the properties of the glass. So please use the GlassMaster Firing Mode with this in mind. For more advanced projects you may want to design your own firing program using the Ramp and Hold Mode.

FAST	1/8" Thick - 18" diameter or smaller 1/4" Thick - 4" diameter or smaller 3/8" Thick - Not recommended
MEDIUM	1/8" Thick - 20" diameter or smaller 1/4" Thick - 8" diameter or smaller 3/8" Thick - 5" diameter or smaller
SLOW	1/8" Thick - 24" diameter or smaller 1/4" Thick - 18" diameter or smaller 3/8" Thick - 12" diameter or smaller 1/2" Thick - 8" diameter or smaller

The program asks for 2 pieces of data, **Speed** and **Process (process refers to whether the piece is to be (Slumped, Tack Fused or Full Fused))**. Use the guidelines in the table above to determine the proper firing **Speed** for your project. When a speed is chosen the controller will set the Heating and Annealing portions of the program. When the process is selected the controller adjusts the 2 process segments of the program based on the process you select. For a complete list of Glass Fire Mode programs see the following page. To modify the peak temperature and hold times of these programs see the Modify Glass Fire menu instructions on page 15.

Glass Fire Mode Programming Steps

Step 1

From Idle (Idle) mode, press **Glass Fire**

(Kiln is in Idle mode when display is flashing "Idle". If the kiln is reading "PF" press ENTER to return to Idle mode.)

Display will read **HEAt** (Heat).

Step 2

Press **CYCLE** key to toggle to one of the 3 firing speeds, either **SLW** (Slow), **MEd** (Medium), or **FAST** (Fast).
Press **Enter**.

Display will read **PrOC** (Process).

Step 3

Press the **CYCLE** key to toggle to one of the 3 firing processes, either **SLP** (Slump), **tAC** (Tack Fuse) or **FULL** (Full Fuse).
Press **Enter**.

Display will revert to **Idle mode**

If the display reads °F it is in advanced mode. See instructions on page 15 regarding "Modify Glass Fire".

Step 4

Press **REVIEW** to verify the correct program has been entered.
Press **Start**.

After pressing review the display will flash all the data entered. After pressing start the kiln will begin firing and display the internal temperature of the kiln. (Unless a Delay Start is programmed.

Step 5

When the kiln reaches the process temperature range, visually inspect the glass and press Add Temp, Add Time, or Anneal Now if needed.

The process temperature for Tack fusing is set for a minimum level of fusing. For a more aggressive level of fusing it will be necessary to Add Time or Temperature.

Full Fuse Programs

Full Fuse - SLOW	1	2	3	4	5	6	7	8
Rate (°F/HR)	300	300	300	600	600	9999	30	60
Temperature (°F)	250	500	750	1250	1480	1000	970	750
Hold Time (HR.Min)	00.25	00.25	00.25	00.20	00.15	02.00	02.00	00.01

Full Fuse - MED	1	2	3	4	5	6	7	8
Rate (°F/HR)	500	500	500	600	600	9999	90	120
Temperature (°F)	250	500	750	1250	1480	1000	970	750
Hold Time (HR.Min)	00.12	00.12	00.12	00.20	00.15	01.00	01.00	00.01

Full Fuse - FAST	1	2	3	4	5	6	7	8
Rate (°F/HR)	800	800	800	600	600	9999	200	200
Temperature (°F)	250	500	750	1250	1480	1000	975	750
Hold Time (HR.Min)	00.05	00.05	00.05	00.20	00.15	00.10	00.20	00.01

Tack Fusing Programs

Tack Fuse - SLOW	1	2	3	4	5	6	7	8
Rate (°F/HR)	300	300	300	600	600	9999	30	60
Temperature (°F)	250	500	750	1250	1350	1000	970	750
Hold Time (HR.Min)	00.25	00.25	00.25	00.20	00.10	02.00	02.00	00.01

Tack Fuse - MED	1	2	3	4	5	6	7	8
Rate (°F/HR)	500	500	500	600	600	9999	90	120
Temperature (°F)	250	500	750	1250	1350	1000	970	750
Hold Time (HR.Min)	00.12	00.12	00.12	00.20	00.10	01.00	01.00	00.01

Tack Fuse - FAST	1	2	3	4	5	6	7	8
Rate (°F/HR)	800	800	800	600	600	9999	200	200
Temperature (°F)	250	500	750	1250	1350	1000	975	750
Hold Time (HR.Min)	00.05	00.05	00.05	00.20	00.10	00.10	00.20	00.01

Slumping Programs

Slump - SLOW	1	2	3	4	5	6	7	8
Rate (°F/HR)	300	300	300	600	600	9999	30	60
Temperature (°F)	250	500	750	1150	1220	1000	970	750
Hold Time (HR.Min)	00.25	00.25	00.25	00.05	00.05	02.00	02.00	00.01

Slump - MED	1	2	3	4	5	6	7	8
Rate (°F/HR)	500	500	500	600	600	9999	90	120
Temperature (°F)	250	500	750	1100	1220	1000	970	750
Hold Time (HR.Min)	00.12	00.12	00.12	00.05	00.05	01.00	01.00	00.01

Slump - FAST	1	2	3	4	5	6	7	8
Rate (°F/HR)	800	800	800	600	600	9999	200	200
Temperature (°F)	250	500	750	1100	1220	1000	975	750
Hold Time (HR.Min)	00.05	00.05	00.05	00.05	00.05	00.10	00.20	00.01

Description

The **Ramp and Hold Mode** allows the operator to design their own firing programs. A **Firing Program** consists of 1 or more segments strung in succession which give the kiln instructions on how to control the temperature. The GlassMaster controller will store up to 6 custom designed programs in permanent memory.

A **Segment (SEG)** consists of 3 pieces of information:

The Rate (rA)- The measurement of how fast or slow the temperature rises or falls at various points in the firing. This is programmed degrees Fahrenheit or Celsius per hour.

The Temperature (°F) - This can be the peak temperature of the firing program, a point in the firing program that signals the rate to change, or that signals a hold or soaking period. This is entered in degrees Fahrenheit or Celsius.

Hold (Hld) - A “Hold” is a period of time in which the kiln remains at a specific temperature. This is often referred to as a soaking period. This is entered in Hours and Minutes. The digits to the left of the decimal represent hours and the digits to the right of the decimal represent minutes. Therefore 90 minutes can be represented by “01.30” or “00.90”.

A single program can consist of up to 8 segments. A segment can control the cooling as well as the heating of the kiln. It is important to remember that a segment that controls the cooling of the kiln can only slow the natural cooling rate of the kiln. It is possible to string two programs together to create a 16 segment program. See the 16 Segment Programs section for instructions.

In order to insure programming success it is very important to have a good understanding of heating glass and how your GlassMaster works to control the kiln. Please refer to the General Firing Guidelines section of the manual before programming the kiln.

SAMPLE FUSE PROGRAM

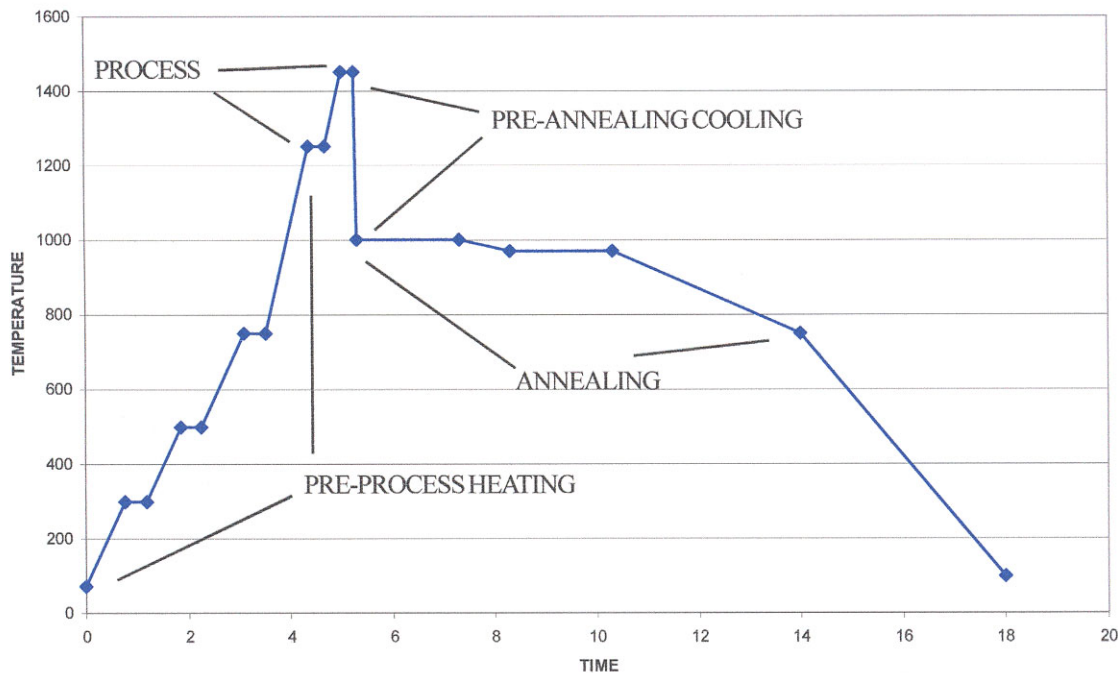

Please read the Kiln Safety and General Firing Guidelines before programming your kiln.

The controller must be in **IDLE Mode** before you can enter a program. When the kiln is in idle mode it will flash **IDLE** alternately with the current temperature of the kiln chamber. Press **STOP** if the kiln is not in **IDLE Mode**

Ramp and Hold Mode Programming Steps

Step 1

From Idle Mode, press **RAMP/HOLD**.

Display will read “PRG” (Program)

Step 2

Enter the **PRG Number** of the program you wish to create or run. *(This is a number between 1 and 6 that you assign to a program which will be stored in permanent memory until it is replaced.)*

Press **ENTER**

Display will read “SEGS” (Segments)

Step 3

Enter the **number of segments** in your program.

Press **ENTER**.

Display will read “rA” 1 (Rate #)

Step 4

Enter the **first heating rate** in degrees per hour.

Press **ENTER**.

Display will read “°F” (Degrees Fahrenheit)

Step 5

Enter the **first temperature to reach**.

Press **ENTER**.

Display will read “HLd1” (Hold #)

Step 6

Enter the amount of **hold time** in hours and minutes.

Press **ENTER**.

Display will read “rA2” (Rate #) unless it is a 1 segment program then it will read ALAr (Alarm)

Step 7

Repeat steps 4 through 6 until all segments have been completed. The display will then flash **ALAr** (Alarm). The default setting for no alarm is 9999. See section on programming alarm for more details.

Press **ENTER**

Display will return to Idle Mode

Step 8

The display then return to Idle mode. At this point the program is loaded and ready to start. Before pressing **START** it is a good idea to press **REVIEW** to make sure the program was input correctly. If you are satisfied with the review, press **START** and the program will began firing.

The display will read the internal temperature of the kiln chamber unless a delay start has been programmed in which case it will began counting down minutes from the designated Delay time.

After the program is running you may wish to use the **ANNEAL**, **ADD TIME**, or **ADD TEMP** keys to alter when the kiln begins it's annealing cycle based on the look of the glass during the final hold of the heating cycle. For instructions on using these features consult the Additional Programming Features section of the manual.

Storing and Recalling programs.

When inputting a Ramp and Hold Program the first piece of information that is entered is the “**PRG**” number. The program number is a memory location to store programs that you would like to use again in the future. You can store up to 6 programs by assigning them **PRG** numbers.

It is helpful to keep a list of all the programs that you have stored in memory. If you are entering a new program and choose a **PRG** number that already contains a program, you will write over that program. So always be sure to choose a **PRG** number which does not contain a program you wish to save.

To recall a program:

1. Press **RECALL**
2. Enter the **PRG** number where your program is stored, then **ENTER**.
3. The program is now loaded.
4. Press **REVIEW** to be sure you have loaded the correct program.
5. Press **START** to run the program.

16 Segment Programs

To program a 16 segment Ramp and Hold program the operator links 2 programs together. This is done by using a MENU feature to link programs 5 and 6 together.

1. Enter the first 8 segments of a Ramp/Hold program in the #5 PRG position.
2. Enter remaining segments of the Ramp/Hold program in the #6 PRG position.
3. **RECALL** program # 5 (*see RECALL instructions above*).
4. Press **MENU** (*The controller must have program #5 loaded in order to see “16-S” in the MENU options.*)
5. Continue to press **MENU** until the display reads **16-S**. (16 Segment). 16-S must be toggled on each time this feature is used.
6. Press **ENTER**
7. Press **REVIEW**. Review will only show the information in segment 5. Review will indicate that 16 segments have been programmed.
8. Press **START**

Skip Step

It is possible to advance to the next segment of a firing program while it is running in Ramp and Hold Mode and Glass Fire Mode. This feature is similiar to the Anneal Now key however it may be used on any segment of the program not just the final heating segment. To use this feature press the **VIEW** key and then promptly press the **ENTER** key. The display will then read **SStP**. If you press **ENTER** at this point the program will advance to the next segment of the program. If you do not press **ENTER** the program will continue in the current segment.

KEYS

ANNEAL NOW

The ANNEAL Now key is used to advance the program to the first segment of the cooling phase of a firing program. It is generally pressed after a visual inspection of the project in the kiln reveals the glass has achieved the desired fusing or slumping results in the process phase and continuing would create too much heatwork. The ANNEAL Now key can only be used during the last heating segment of a RAMP/HOLD program or segment 5 of a GLASS FIRE program.

ADD TIME

The ADD TIME key is used when a visual inspection of the project in the kiln reveals that the proper amount of heatwork will not be achieved given the amount of time remaining in the final HOLD segment of the Process Phase (*Refer to HEATWORK in the General Firing Guideline section of this manual*). Pressing the ADD TIME KEY will add 5 minutes to any HOLD segment. The program must be in the HOLD portion of the segment (*display is counting down in minutes*) for this feature to work.

ADD TEMP

The ADD TEMP key is used when a visual inspection of the project in the kiln reveals that the proper amount of heatwork will not be achieved given the peak temperature input in the final heating segment of the Process Phase (*Refer to HEATWORK in the General Firing Guideline section of this manual*). Pressing the ADD TEMP key will add 5 °F to the final heating segment of the process. The program must be in the heating portion of the segment (*display is increasing in temperature*) for this feature to work.

BACK

The BACK key can be used at any time during programming to move “back” in the program being entered to change or correct data entered.

CYCLE

CYCLE is used in conjunction with the Glass Fire Mode to “cycle” to the desired speed and process. *See Glass Fire Mode Programming Steps.*

ENTER

The ENTER key is used to “enter” selected data in the controller.

MENU

The MENU key is used to access advanced programming options. *See MENU FEATURES.*

REVIEW

The Review mode allows you to review a program before you fire the kiln. It “reviews” the program that is currently loaded in the controller. The review key can safely be pressed when the kiln is in IDLE Mode. **Caution: Pressing Review during firing momentarily stops operation of the kiln, allowing temperature to drop. This can be harmful to the glass during critical points in the firing.**

RECALL

The RECALL key is used to “recall” a stored RAMP/HOLD program. *See Storing and Retrieving Programs.*

START

The START key is used to begin a program after it has been entered and reviewed. If the START key is pressed after a program has been stopped, the controller will begin the firing in the first segment of the program that contains the current temperature of the kiln.

STOP

Pressing the STOP key will “stop” the current firing and return the display to IDLE Mode. You can stop the kiln any time during operation.

VIEW

The View function is used during a firing to display the current segment of a program currently in operation.

MENU FEATURES

The following programming features can be accessed by pressing the MENU key. Continue to press the menu key until you reach the menu feature you want and then press ENTER to select it.

ALARM (ALAR)

The Alarm sounds when the kiln has reached the alarm temperature programmed. The alarm sounds until it is turned off by pressing *ENTER*. The alarm does not interrupt the firing nor does pressing Enter to stop the alarm. The alarm temperature can be reset during a firing without disturbing the firing program. **Do not press Stop during the firing to reprogram the alarm.** When not in use, the alarm should have a value of 9999 entered so it will not sound. The Alarm can be programmed when the internal kiln temperature is flashing. Press *ALARM* then input the *TARGET ALARM TEMPERATURE* and press *ENTER*.

DELAY START (DELA)

Delay start allows the operator to program the kiln for a start at a later time. The option provides for a delay programmed in hours and minutes up to 99 hours and 99 minutes. The delay time is held in memory from one firing to another. To clear the option without clearing the entire program, enter 00.00 for delay time. A Delay can be programmed when the internal kiln temperature is flashing. Press *DELAY* then input the *HOURS AND MINUTES* and press *ENTER*. When the program is started the display will begin counting down from the programmed delay time.

MODIFY GLASS FIRE (MGF)

This Menu feature allows you to change the Temperature and Hold values in the 5th segment of a Glass Fire Mode program. When “MGF” is toggled “ON” the display will ask the programmer to enter Temperature and Hold values each time a Glass Fire program is entered. If these values are changed and MGF is toggled to “OFF”, the new values will be automatically inserted for all the combinations of Process and Speed that were modified. *(If you wish to revert back to factory defaults see the Factory Default menu option instructions)* To change the MGF setting:

- 1) Press MENU until MGF appears in the display and press ENTER,
- 2) Display will read “ON” or “OFF” depending on the current setting. To change the setting press the BACK key and then ENTER

BOARD TEMPERATURE (BD T)

This menu option allows you to view the temperature of the circuit board. The board should not exceed a temperature of 155 °F.

LAG TEMPERATURE (LAG)

This feature is only relevant for kilns with multiple thermocouples. Contact Skutt for details on adjusting the LAG.

TEMPERATURE SCALE SELECTION (CHG°)

You can select either the Fahrenheit or Centigrade temperature scale. The scale must be set at its desired position before pressing Start. Do not change the scale during a firing. The scale remains in permanent memory. When there is a small light in the lower right corner of the display the Centigrade scale is selected.

16 SEGMENT PROGRAM (16-S)

This menu option links program 5 and program 6 to create a 16 segment program. *See 16 Segment Program section of the manual for instructions.*

KISS ID (Id)

This is the ID # used for ordering a computer interface package for the controller. Call Skutt for more information.

THERMOCOUPLE OFFSET (TCoS)

This feature allows the programmer to adjust how the circuit board interprets the information from the thermocouple. Please contact Skutt before using.

RESET AND GLASS FIRE DEFAULTS (RSEt)

Reset restores the settings to factory defaults.

ERROR CODES ON/OFF (ERCD)

It is not recommended to turn error codes off without consulting Skutt.

ALAr

A temperature between 0° and 9999° that can be programmed to alert the operator to take action.

CHG°

Changing from Fahrenheit to Centigrade or the reverse. When operating in Centigrade a decimal will appear in the lower right corner of the display screen.

CPLt

The controller has completed a firing profile. The firing time in hours and minutes is displayed. The user needs to press Enter. The controller will display the current internal temperature of the kiln.

deLA

Indicates time in hours and minutes before start of firing.

Err

A software error has occurred. Press any key to display the elapsed firing time and the temperature when the error occurred. Refer to the table of Errors on page 22.

F1, F2, F3, F4, F5, F6, F7 or F8

The controller is in Ramp/Hold mode. The user needs to enter an end temperature in °F or °C for **each** segment of the firing profile.

FAIL

The thermocouple and controller are not properly connected. Fix the connection, then press **Enter** to display the kiln's current temperature. Press **Start** after the connection is fixed. The thermocouple could be damaged. Check the connections, if still no luck you may need a new thermocouple.

FULL

The controller is in Glass Fire Mode and is asking for a process. FULL represents Full Fuse. If you wish to select this option press ENTER or press Cycle to advance to the next option

HOLD

Indicates a holding time in hours and minutes at the end of a Cone Fire program.

HLd1, HLd2, HLd3, HLd4, HLd5, HLd6, HLd7 or HLd8

The controller is in Ramp/Hold programming mode. The user needs to enter a period of time in hours and minutes that the controller should maintain for **each** segment of the firing profile.

IDLE**-ON-**

Briefly displayed at the beginning of firing to indicate that the kiln has started.

PF

Displays at the time the kiln is initially powered up. Press **Enter** to clear the message and internal kiln temperature will flash. PF also signals when the controller has experienced a power failure of more than 2 minutes.

rA1, rA2, rA3, rA4, rA5, rA6, rA7 or rA8

The controller is in Ramp/Hold programming mode. The user needs to input an appropriate temperature in °F/hr or °C/hr for **each** segment in the profile.

SEGS

(Looks like SE65) The controller is in Ramp/Hold mode. The user needs to enter the number of segments in the firing program.

SLP

The controller is in Glass Fire Mode and is asking for a process. SLP represents Slump. If you wish to select this option press ENTER or press Cycle to advance to the next option

SPd

The controller is in Glass Fire mode. The user needs to enter the appropriate speed; slow, medium or fast for this firing.

STOP

Designates the intentional termination of a program while in operation.

tAC

The controller is in Glass Fire Mode and is asking for a process. tAC represents Tack Fuse. If you wish to select this option press ENTER or press Cycle to advance to the next option

PRG

A prompt at the beginning of a Ramp/Hold program which allows the programmer to choose a stored program. Choose a number between 1 and 6 to store or run a program.

flashing temperature

The kiln is off and the display is showing the kiln's current temperature.

alternating display of time and temperature

The kiln is in a Ramp/Hold firing profile and is in the soak stage. The display is indicating the kiln's internal temperature and the remaining Hold time for that segment.

decreasing time

The kiln is in a Delay start segment of a Glass Fire or Ramp/Hold mode. The display is showing the remaining time before the kiln starts to heat.

steady temperature

the kiln is in the ramping stage of either a Glass Fire or Ramp/Hold fire profile. The display is showing the kiln's current internal temperature.

decimal point between 10's and 100's

Hours.minutes being displayed.

right hand decimal point on in lower right hand corner

Kiln is operating in °C mode. To revert back to °F mode see Menu Features.

The following guidelines just scratch the surface of the knowledge base associated with firing glass. We highly suggest you take a firing class from your local distributor. If classes are not available in your area there are numerous books available on the subject that can be found at bookstores and on the internet.

What is a Firing Program?

Glass is very sensitive to changes in temperature below 1000 °F. If it is heated or cooled too quickly through certain temperature ranges it creates stress within the glass which can cause breakage. Firing programs are used to control these temperature rates and limit the amount of stress created within the glass as well as create the desired effect on the glass.

A firing program is composed of one or more firing segments that dictate the heating or cooling rate through out the program. Each one of the lines in the chart represents a segment or hold time within a segment and the slope of the line represents the rate of firing. A firing program is either entered into a kiln controller or on kilns without controllers it is replicated by turning up and down temperature switches .

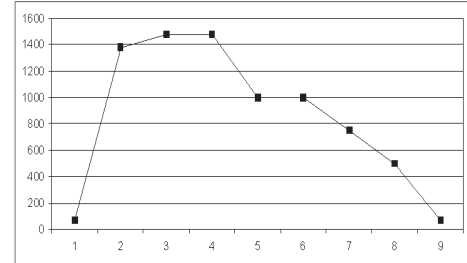

Type of Glass

The art of firing glass has been around for centuries however, comparatively speaking, it has only been recently that companies have begun manufacturing glass specifically designed to fuse together. Glass, like most everything on earth, expands when exposed to heat and contracts when it is cooled. It expands at a measurable rate, known as the COE, or coefficient of expansion, and as it becomes liquid it flows at different rates which is referred to as it's viscosity level.

These variables and a host of others must be carefully managed to create glass that can be fused together without crazing, cracking, warping, or breaking. Always consult with your supplier of glass to determine if the glass you wish to fuse is compatible.

Heatwork

Heatwork is a term used to describe the relationship of time and temperature and their combined effects on glass. To a certain extent the two are inversely related. This means that the higher the temperature the less time is needed to create the same effect and likewise, the lower the temperature the more time is needed.

This concept becomes most useful at the "Working" temperature range of glass. This is the temperature range where the glass is fused, slumped or sagged. Most fusing glass will fuse between 1450 F and 1480 F. It is possible to get the same results (or the same amount of heatwork), by bringing the kiln to 1450 F and holding it at that temperature for 30 minutes as you would by bringing the kiln to 1480 F and holding it for only 10 minutes. There may be other factors that make you choose one working temperature over the other such as the thickness of the project.

Size and Mass

The size of the piece is one of the most influential factors for creating a firing program. One of the keys to successful heatwork is having the entire piece go through critical temperature ranges at the same moment. When a piece is thick it takes longer for the center to heat up then it does the outside of the piece. When it is a large diameter slight differences in temperature throughout the chamber of the kiln can cause the piece to expand at different rates.

The key to firing larger and thicker pieces is to slow the firing rates through critical temperature ranges. Determining how slow is often a trial and error proposition therefore it is best to start with a conservatively slow program. More projects are ruined by going too fast than too slow

Critical Temperature Ranges

A “Critical Temperature Range” is any temperature or temperature range in the firing cycle that has a high level of potential for limiting the success of the project. Limited success can be expressed as overfired, underfired, breakage, devitrification, bubbles just to name a few. It can be argued that there are numerous critical temperature ranges. To keep things simple we are going to discuss the primary four: Heating Range, Process Range, Pre- Annealing Cooling Range, and Annealing Range.

HEATING RANGE

The Heating Range goes from room temperature to the first set of data in the Process Range. The only concern during this range is heating the pieces too fast without adding steps to the program. Steps are hold periods at designated temperatures that allow the piece to balance out during the firing. Small pieces can normally be heated as fast as 800 F./Hr. as long as steps are added. With larger pieces you will want to slow the rate and possibly add additional steps depending on the size of the piece.

PROCESS RANGE

The Process Range is the temperature range where the material begins to visibly change. It is this stage that determines the final shape of the piece. It is often a good idea to add a pre- Process Range segment to slow the kiln down before entering the Process Range. If the kiln is firing too fast into the process range it is possible to overshoot your goal temperature.

During the Process Range temperatures and hold times are key. If you are unsure of the desired peak temperature you may want to start on the low end of the range with a longer soak. This will help insure that thicker pieces receive the proper heatwork throughout the entire piece. The process you are wishing to create will dictate the specific cycles of this range.

PRE-ANNEALING COOLING RANGE

After the process range is through, it is desirable to cool the piece quickly for several reasons. The first is to stop the heatwork. This is especially important on a project such as a less than 100% fuse or a drop mold.

The second reason is that an undesirable reaction known as devitrification can occur during this cooling period if the kiln is cooled too slowly. Devitrification is a scummy white crystallization on the glass surface that is difficult if not impossible to remove. Be sure to slow down the cooling before you enter the Annealing Range.

Opening the kiln lid to increase the rate of cooling, while practiced, is not always recommended. On certain models the thermocouple is in the rear of the kiln and the temperature from front to back can vary greatly causing part of the piece to enter the annealing phase before the part in the rear.

ANNEALING RANGE

The final critical range is the Annealing Range. Every piece of glass has an annealing point, that is a point in the cooling cycle where the molecules in the glass realign themselves into a solid and stable form. It is very difficult to know exactly where that specific point will be so during this period it is critical to fire the kiln at a slower rate throughout the range.

Our pre- programmed firing schedules in the Glass Fire Mode anneal from 1000 °F to 750 °F which should be adequate for most stained glass. By incorporating such a broad range the risk of breakage is limited. Be sure to keep the lid or door of the kiln closed until the kiln reaches room temperature. Opening the lid too soon can cause pieces to break.

Firing Processes

There are many different processes or techniques used for manipulating glass with heat inside a kiln. In this manual we will focus on two, Fusing and Slumping. Other techniques include but are not limited to Drop Molds, Pate de Verre, Casting, Painting, and Combing. For more information on using your kiln with these techniques please consult your glass supplier.

FUSING

Fusing is the process of joining 2 or more pieces of glass together by the application of heat. This glass can be in the form of sheets, stringers, frit or a host of other forms. There are different degrees of fusing. You may want to fuse glass so it sticks to another piece of glass without deforming. This is known as a "Fuse to Stick". If you were to apply more heatwork to the piece the edges would round slightly. This is known as a "Tack Fuse". A "Full Fuse" is created when the pieces have melted completely together and are 1/4" thick. A "Texture Fuse" is any point inbetween a Fuse to Stick" and a "Full Fuse".

There is a temperature range at which glass can be fused. The point at which it begins to fuse is influenced by the rate at which the temperature is climbing when it reaches the fusing range. Most fusing glass will begin to fuse between 1400 F and 1480 F. Remember that heatwork is a function of time and temperature

Starting with glass that has been determined to be compatible is only the beginning to a successful fusing or slumping project. The temperature and various temperature rates in a firing program must be designed to the specific needs of the project you are creating. The size, thickness, shape, and type of glass all must be considered when designing a firing program.

The Glass Fire programs take advantage of a preprocess cycle that allow the pieces to slowly enter the working temperature of the process phase. This helps the glass achieve greater heat uniformity and allows air bubbles between layers a chance to escape before they are sealed between the layers. As a precaution you may want to provide a dam or barrier around the glass when fusing more than 2 layers. With more than 2 layers, the glass will spread until it finds a level of 1/4" and could possibly flow into another piece or off the shelf.

SLUMPING

Slumping can be defined as the controlled bending of glass under the influence of heat and gravity within a kiln. This is generally done over or into a mold. Molds can be made out of a variety of different materials and can be found at art glass supply businesses.

When slumping it is necessary to take into account the shape of the mold, the thickness of the piece, and the degree of heatwork desired. The GlassFire mode may be used when the mold is simple and shallow, however deeper more complex molds, may require a custom designed firing program and close supervision.

Gravity plays a very important role in slumping, especially slumping over a mold as opposed to into a mold. If the shape of the mold dictates that the unbent glass is largely unsupported, the weight of the unsupported glass will pull the glass over the mold quicker then if only a small portion is unsupported.

A thin piece of glass will bend quicker than a thick piece of glass. A thick piece of glass requires more Hold time in the final segment of the process phase.

In some cases the artist may want to control the amount of bend by visually inspecting the kiln. Be sure to follow the safety guidelines listed in this manual when using this technique. When the proper amount of heatwork is reached the artist can press the ANNEAL NOW key to advance the kiln into the cooling cycle. Slumping projects that receive too much heatwork can take on unwanted texture from the mold or in extreme cases fuse to a puddle.

If you find yourself in this section of the manual please remember that Skutt and your Skutt Kiln distributor are here to help you as long as you own your kiln. If you are unable to determine the problem, or just need to order parts, please let us know.

KILN WILL NOT START

If there is no display, check to see if the kiln is plugged in and the breaker has not tripped. If there is a display, double check your programming instructions. The kiln must be in Idle Mode to start.

KILN WILL NOT REACH TEMPERATURE

Make sure the kiln is connected to the proper voltage. After extended use the elements in the kiln wear out and eventually need to be replaced. Look for possible breaks in an element. Elements can break if they are contaminated by bits of glass. If an element is out it will not glow. Program the kiln to at least 500 °F and look in the kiln to see if any individual elements are out.

Kilns cycle power on and off through relays. If a relay goes out, 1 or more elements in the kiln will not function. Look at the wiring diagram to determine if elements not glowing are connected to the same relay. If they are, chances are that relay needs to be replaced. Skutt recommends to replace all relays at the same time.

KILN OVERFIRES OR UNDERFIRES

The thermocouple, which looks like a metal tube protruding into the kiln chamber, measures the temperature in the kiln chamber. As thermocouples began to wear out they slowly drift in the direction of an overfire. If you have noticed that your projects have become increasingly overfired it may be time to change your thermocouple. If you are comparing your results to how they fire in other kilns it is important to remember that every kiln fires slightly different and it may be necessary to adjust your firing programs.

KILN WILL NOT TURN OFF

Kilns cycle power on and off through relays. If a relay sticks on 1 or more elements in the kiln will stay on. Skutt kilns are specifically designed to split the power between 2 or more relays therefore the likelihood of a severe over fire is extremely unlikely. Look at the wiring diagram to determine if elements glowing are connected to the same relay. If they are, chances are that relay needs to be replaced. Skutt recommend to replace all relays at the same time.

ERROR MESSAGES

The following errors may appear in the window of your controller. Along with the error number, the display indicates elapsed time in hours and minutes and also the temperature the kiln reached when the error occurred. Please write these numbers down and call your distributor or Skutt Kilns at (503) 774-6000.

ERROR AND DESCRIPTION

- Err1** Ramping up and rate is less than 12° per hour. Rise is checked every 7.5 minutes. Rate must persist for 22.5 minutes before display.
- Err2** Program in hold, temperature 50° or more above hold temperature. Error must persist for more than 18 seconds before error is triggered.
- Err3** Program in hold, temperature 50° or more below hold temperature. Error must persist for more than 18 seconds before error is triggered.
- Err4** Program ramping down and temperature more than 50° above last hold temperature. Error must persist for more than 18 seconds before error is triggered.
- Err5** Program ramping down and temperature more than 50° below local set point. Must persist for 18 seconds to trigger.
- Err6** Negative reading detected at thermocouple, indicating it is wired improperly.
- Err7** Ramping up and temperature 50° above local set point.
- Err8** Controller in positive ramp, kiln temperature is ramping down. Negative rate must persist for 22.5 minutes to trigger error.
- ErrP** Informational error message: . When it flashes, a brief, noncritical power outage has occurred. The controller was able to resume firing and the load of ware is not in danger. It continues to alternately display with the internal temperature until you press Enter.
- FAIL** System cannot sense thermocouple.

All Skutt Kilns come with a 2 year warranty. This warranty is included in the bag that contained this manual. For details regarding how to obtain what is covered in the warranty and how to obtain warranty service please consult the warranty.

There are certain repairs that can be done fairly easily. All parts come with a complete set of instructions. The following are repairs that can be done by most kiln owners. For more complicated repairs please contact your distributor.

ALWAYS UNPLUG THE KILN PRIOR TO DOING ANY REPAIRS.

BRICK REPAIRS

Generally brick does not need to be replaced or repaired unless the element groove lip is damaged to the point where the element is sagging out of the groove. Small chips and cracks do not effect the performance of the kiln.

SLAB REPAIRS

Melted glass on a properly kiln washed floor can easily be removed without damage to the surface below by scraping the slab with a putty knife.

Holes in the slab up to 1.5 centimeters deep can be patched. Using a sharp knife or X-Acto tool, undercut the edges of the damaged area. To fill the void use "Kiln Patch". This can be ordered through Skutt or may be available at your local distributor. Compress the kiln patch into place, and scrape flush with the rest of the floor. Allow to dry well before firing.

LID REPAIRS

A coating of refractory cement will prevent the brick from crumbling and falling on your ware. Some lids without elements have a flip side if ever needed. Just remove the screws holding the hinge leaves, turn the lid over, and reattach the leaves to new holes drilled in the lid's band.

Major cracks and chips are often times impossible to repair and it will be necessary to replace the lid.

REPLACING ELEMENTS

As elements grow old they oxidize and produce less power. Eventually the kiln will no longer reach temperature and the elements will need replacing. Please consult your distributor when it becomes necessary to replace the elements in your kiln. They will provide you with the correct replacement parts and comprehensive instructions for replacing them correctly.

REPLACING THERMOCOUPLES

Thermocouples are the metal tube shaped objects that protrude into the kiln chamber. They measure the temperature inside the kiln and relay the information to the controller. Over a period of time thermocouples can degrade and need to be replaced. If not bent or broken, thermocouples will generally slowly drift towards an overfire. If you notice an increasing amount of heatwork to your projects it may be necessary to replace the thermocouple.

REPLACING RELAYS

Relays cycle the power on and off in the kiln. Over time the contacts on the relay can wear out and the relay needs to be replaced. It is recommended to replace all of the relays when one goes out.

GM10F

An optional bead door may be purchased any time and fitted to your GM10F.

The GM10F when ordered with a bead door, comes with removable refractory heat baffles designed to protect the operator from electrical shock. This feature was introduced primarily for people inserting mandrels into the kiln while it is firing.

The baffles slide into grooves located in the lid and slab next to the element walls. It may be necessary to slide the baffles back and forth slightly to seat them in the grooves. A 1 5/8" Tri post may be ordered from Skutt to use as a mandrel rest inside the kiln.

Caution: Do not leave the bead door unattended in the open position. Damage could result if the bead door slams shut accidentally. Always raise and lower the bead door gently.

The bead door does not come attached to the kiln and must be assembled. In the box with the kiln you will find the following:

- | | |
|--------------------------------|---|
| 1) 1 Bead Door handle with rod | 4) 1 Bead Door |
| 2) 4 Split Ring Collars | 5) 2 Baffle Plates (1 Left and 1 Right) |
| 3) 1 Allen Wrench | 6) Strips of fiber cloth. |

Step 1

Remove 3 of the 4 split ring collars using the Allen wrench taped to the rod and then slide the bead door rod through the first bracket hole.

Step 2

Slide on another split ring collar and then the bead door.

Step 3

Slide on another split ring collar and then slide the end of the rod through the right hand bracket so the end is sticking out far enough to slide the last collar on flush with the end of the rod.

Step 4

Tighten the 2 out side collars making sure they are flush with the bracket.

Step 5

Center the bead door on the hole, slide the 2 inside collars up flush with the bead door bracket and tighten the set screws. The bead door should be in the closed position and the wooden handle should be pointing directly towards you. Rotate the wooden handle 180 degrees so that it is pointing towards the back of the kiln. The bead door should be completely open. The weight of the wooden handle should hold the bead door in the open position.

Step 6

Open the side hinged door and slide the baffle plates in the grooves near the element walls. The baffle plates have a top and bottom. They need to be positioned so the holes in the baffles are aligned with the element grooves.

Step 7

Place 1 fiber cloth sheet on the bottom edge of the door plate if you are going to be using mandrels. Use 3 sheets if you would like to seal the door for fusing.

Your bead door is now ready for use.



Using the GM10F

ALTERNATE THERMOCOUPLE POSITION

The GM10F thermocouple is positioned in the center of the kiln. This position gives the most accurate reading when the glass is located in the center of the kiln. If this thermocouple position is inconvenient for the work you are doing, it can be moved to an alternate location higher in the chamber. To do this perform the following steps:

1. Unplug the kiln.
2. Remove the back panel of the control box.
3. Remove the screws securing the thermocouple block to the back wall and carefully slide the thermocouple out. Leave the thermocouple attached to the block.
4. Locate the alternate hole location and use the hole as a guide to drill a 1/4" hole through the brick for the thermocouple.
5. Slide the thermocouple into the hole and use a 3/32" drill bit to drill pilot holes for the screws that secure the block.
6. Attach the thermocouple block screws.
7. Stuff previous hole with fiber, replace the back panel and plug in the kiln.

Be sure to test fire the kiln after relocating the thermocouple. The temperature reading at the top of the chamber may be slightly different and therefore you may want to adjust your firing programs to compensate for the difference.

BEAD MAKING TIPS

If you have the GM10F but do not have the bead door we highly suggest you order this option for annealing beads. The bead door is designed to allow you to insert frameworked glass beads on a mandrel conveniently and without losing much heat out of the kiln.

The first step is to program your kiln to heat up to working temperature. This should take about 20 to 30 minutes. Below is a sample 2 segment bead program that can be entered in the Ramp/Hold mode on the controller.

To insert the mandrel just lift the door handle with your free hand and place the bead end of the mandrel through the bead opening. The kiln should already be on and at the suggested temperature. Rest one end of the mandrel on a shelf post and the other end on the ledge of the bead opening. Be sure that the bead is not touching other beads or the post.

When you lower the door there will be a gap between the bottom of the door and the ledge. This is normal and will not cause any problems. If you would like to make the gap smaller when you are fusing just add more fiber strips until you get a good seal.

When you are done working with the torch you will want to press "ANNEAL NOW" on the controller. This will advance the kiln program to the annealing schedule you have programmed. When it is done with the programmed annealing cycle the kiln will shutoff.



	<u>RATE</u>	<u>TEMPERATURE</u>	<u>HOLD</u>
SEGMENT 1	9999	980 F	8 HOURS
SEGMENT 2	300	700 F	0 HOURS

GM22CS

The GM22CS has some unique features that require some clarification.

UNPACKING

The GM22CS comes packed in several boxes. In Box #1 will be the kiln and Operating Manual Packet. In Box #2 will be the Kiln Stand and GlassMaster Controller.

PLACING ON THE STAND

The Kiln Stand needs to be positioned with the buckle latch facing forward. Line up the kiln on the stand so the top half of the latch on the kiln can be attached to the bottom half of the latch on the stand.

MOUNTING THE GLASSMASTER CONTROLLER

- 1) Locate a spot on the wall behind the kiln that is at least 18" from the kiln yet close enough to not stretch the controller cord when it is attached to the kiln. Make sure the location is easy and safe to access and preferably in an area where at least 1 of the mounting screws can be attached to a stud in the wall. If a wall stud can not be accessed it will be necessary to use drywall anchor bolts that can be found at a local hardware store. Using the template in the back of the catalog, mark the holes for drilling.
- 2) Remove the template from the wall and drive the mounting screws (these can be found in your Operating Manual Packet) into the wall in the areas marked. Leave approximately 1/4" of thread showing on the screw to allow for the unit to hang on the screws.
- 3) Hang the GlassMaster Controller on the screws and attach the controller cord to the back box of the kiln using the connector on the end of the cord.

OPENING AND CLOSING THE KILN

The GM22CS's "Clam Shell" design requires shocks to comfortably open the kiln. These shocks have dampeners built into their chambers to keep the kiln from opening too fast. However it is still recommended to control the speed of the lid opening when it is to be opened all of the way. This will reduce the amount of stress placed on the hinges and back row of bricks.

Electrical Requirements

The chart below shows the recommended electrical specifications for each kiln model. If you are uncertain about your existing power, have it checked by an electrician. If you are installing a new kiln, have the electrician follow this guide.

Electrical requirements for Skutt Automatic Kilns

	Voltage	Amp	Watts	Wire Size*	Breaker Size	Max Temp	NEMA Receptacle
GM10F	115	15	1725	10	20	1800	5-15
GM814	240	27.8	6660	8	40	1800	6-50
GM814	208	32	6656	8	40	1800	6-50
GM1014	240	34	8140	6	50	1800	6-50
GM1014	208	39.1	8140	6	50	1800	6-50
GM1414	240	34.7	8320	6	50	1800	6-50
GM1414	208	40	8320	6	50	1800	6-50
GM1414 3ph	240	20	8320	10	30	1800	15-50
GM1414 3ph	208	23.1	8320	10	30	1800	15-50
GM818	240	27.8	6660	8	40	1800	6-50
GM818	208	26.7	5550	8	40	1800	6-50
GM1018	240	39.4	9460	6	50	1800	6-50
GM1018	208	40	8320	6	50	1800	6-50
GM1027	240	48	11520	6	60	1800	6-50
GM1027	208	48	9980	6	60	1800	6-50
GM1027 3ph	240	29.3	11520	8	40	1800	15-50
GM1027 3ph	208	31.7	11000	8	40	1800	15-50
GM1227	240	48	11520	6	60	1800	6-50
GM1227	208	48	9980	6	60	1800	6-50
GM1227 3ph	240	29.3	11520	8	40	1800	15-50
GM1227 3ph	208	31.7	11000	8	40	1800	15-50
GM22CS	240	31	7450	6	40	1800	6-50
GM22CS	208	35.8	7450	6	40	1800	6-50
GM22CS 3ph	240	17.9	7450	10	30	1800	15-50
GM22CS 3ph	208	20.7	7450	10	30	1800	15-50

All Skutt kilns are equipped with a type K thermocouple.

***For each additional 50 feet use heavier wire**, numerically two numbers lower—for example, instead of #10, use #8. If you anticipate installing any larger kiln in the future, use the heavier wire.

GM814

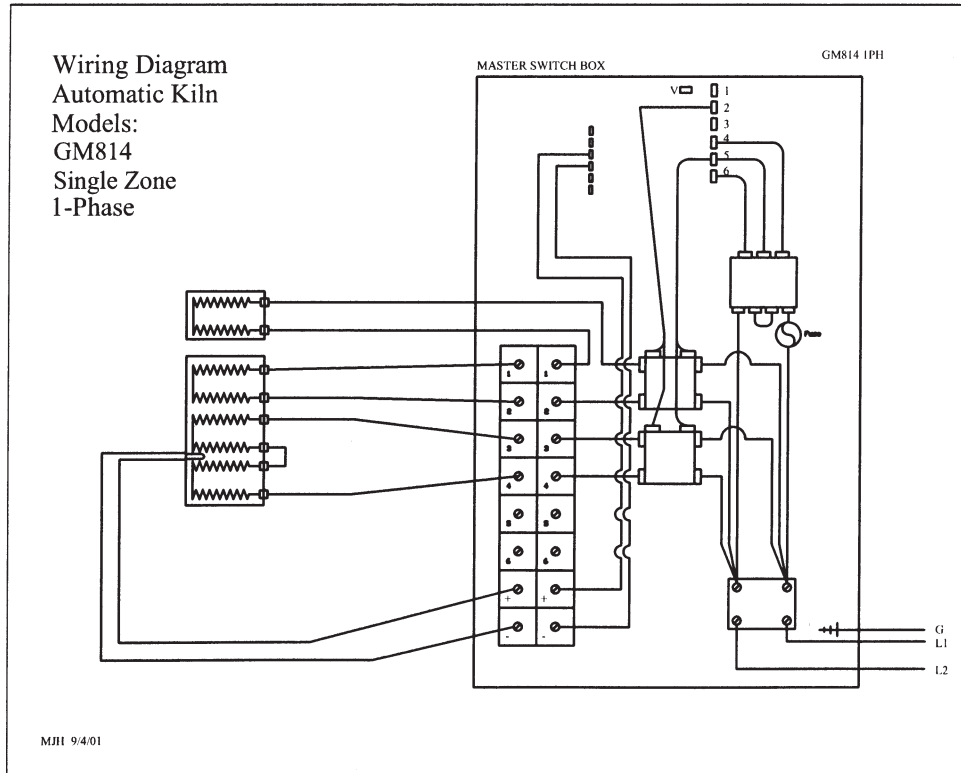

GM1014

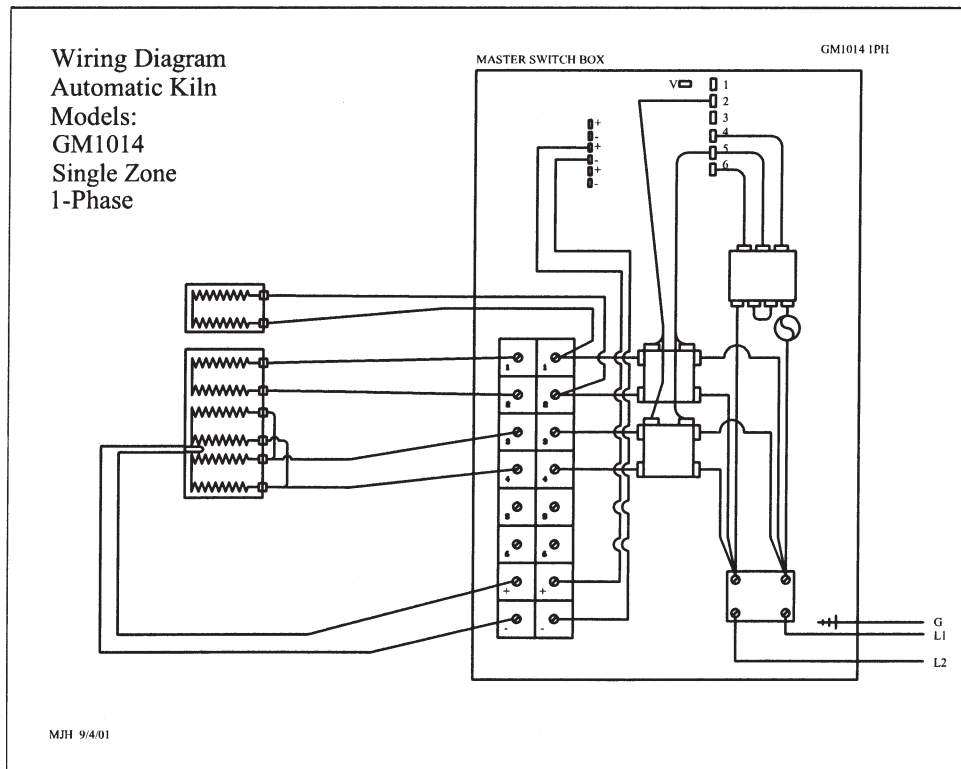

GM1414 1PH

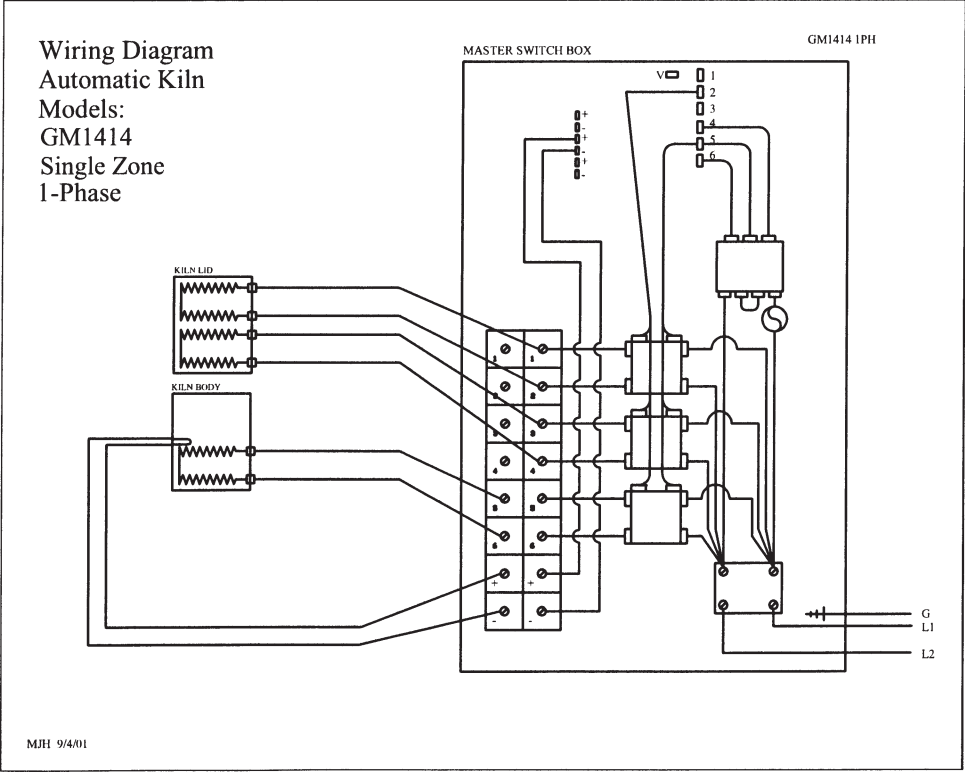

GM1414 3PH

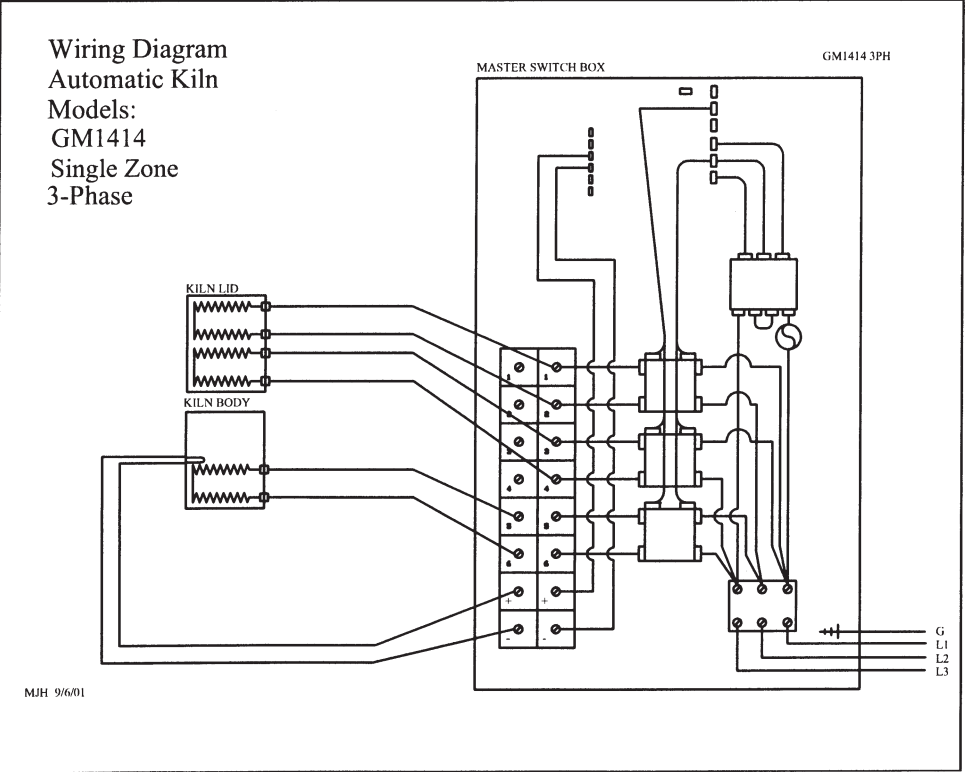

GM818

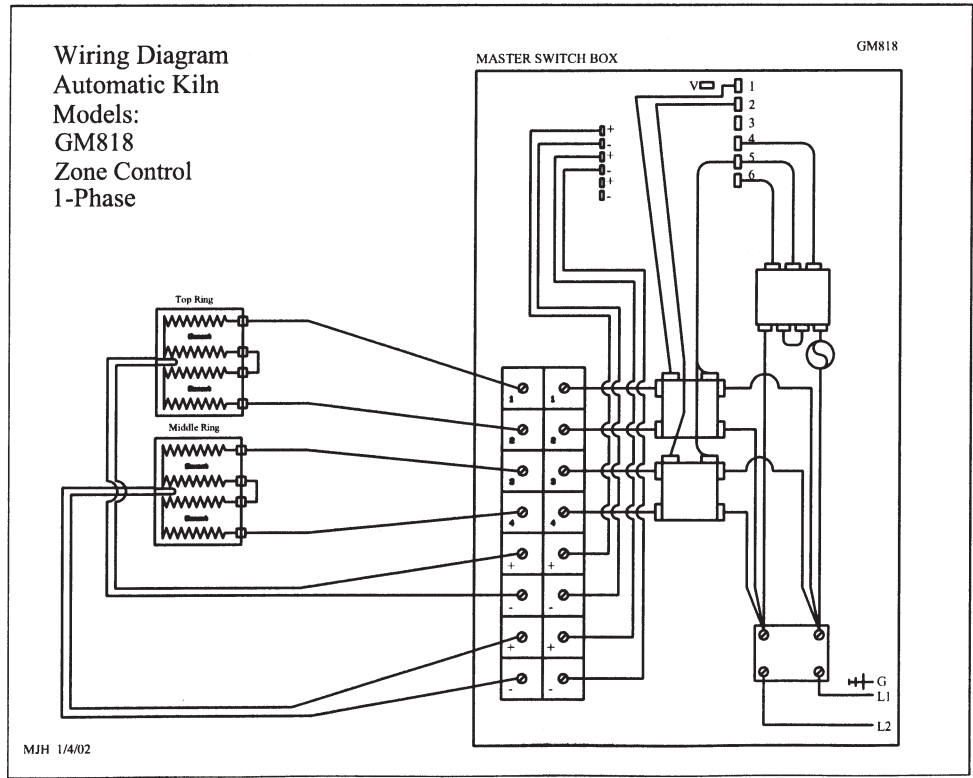

GM1018

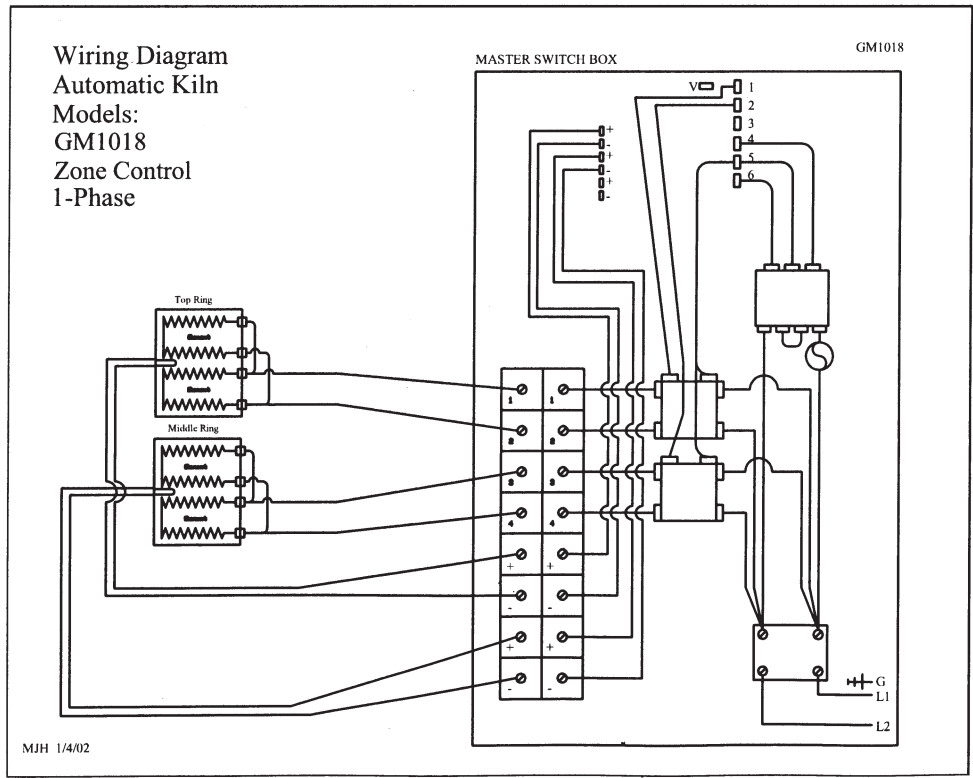

GM1027/GM1227 1PH

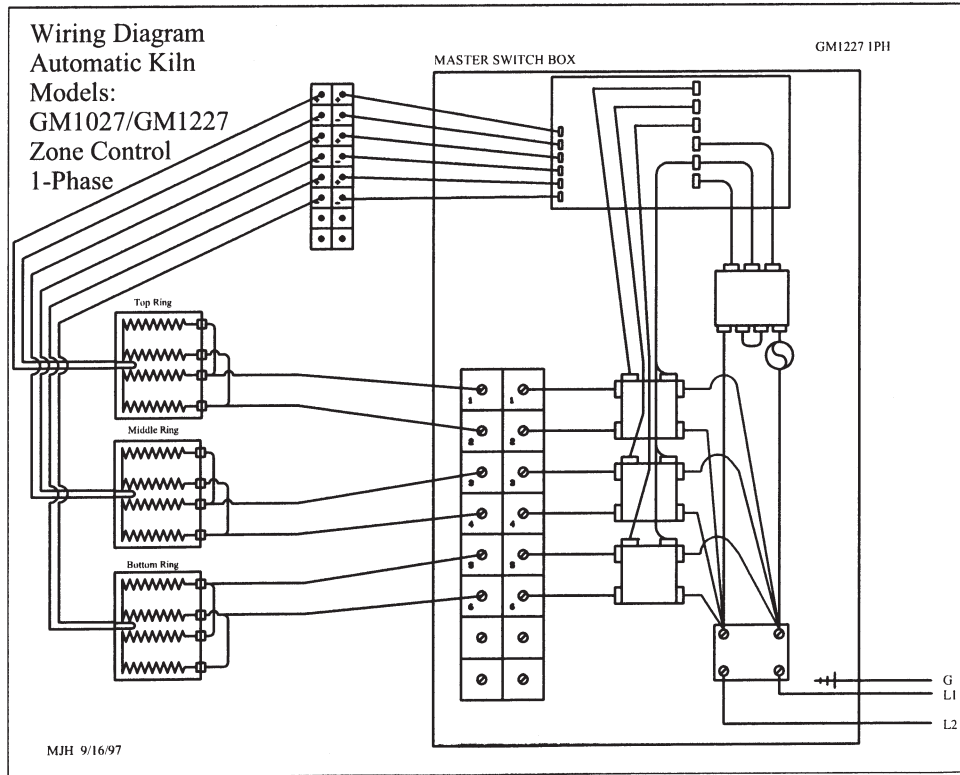

GM1027/GM1227 3PH

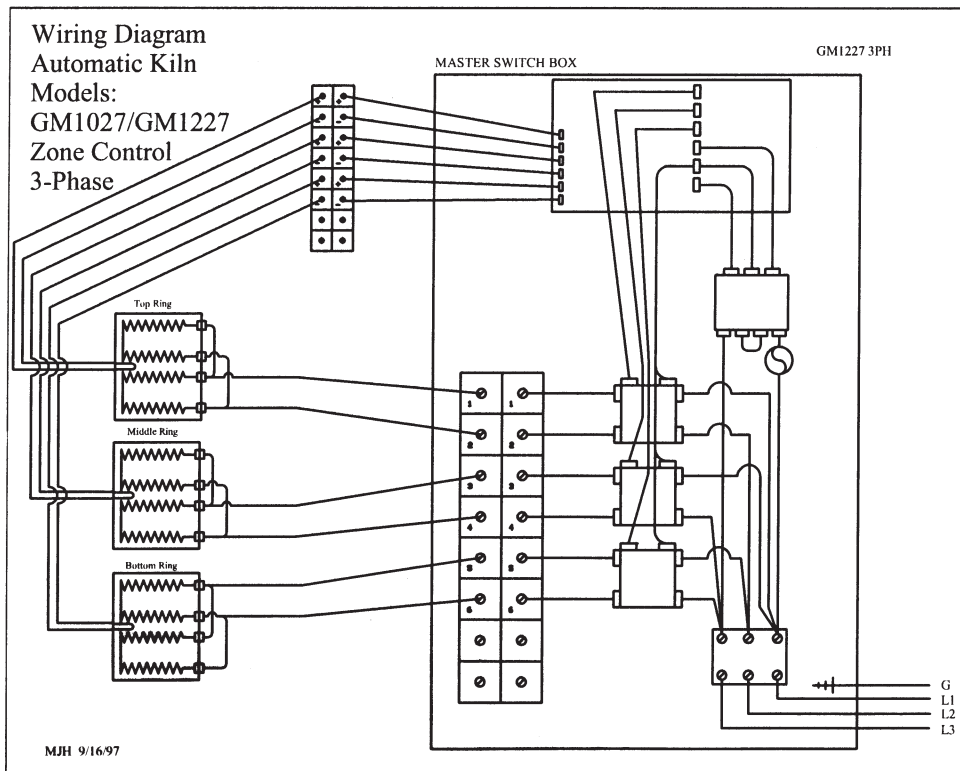

GM22CS 1PH

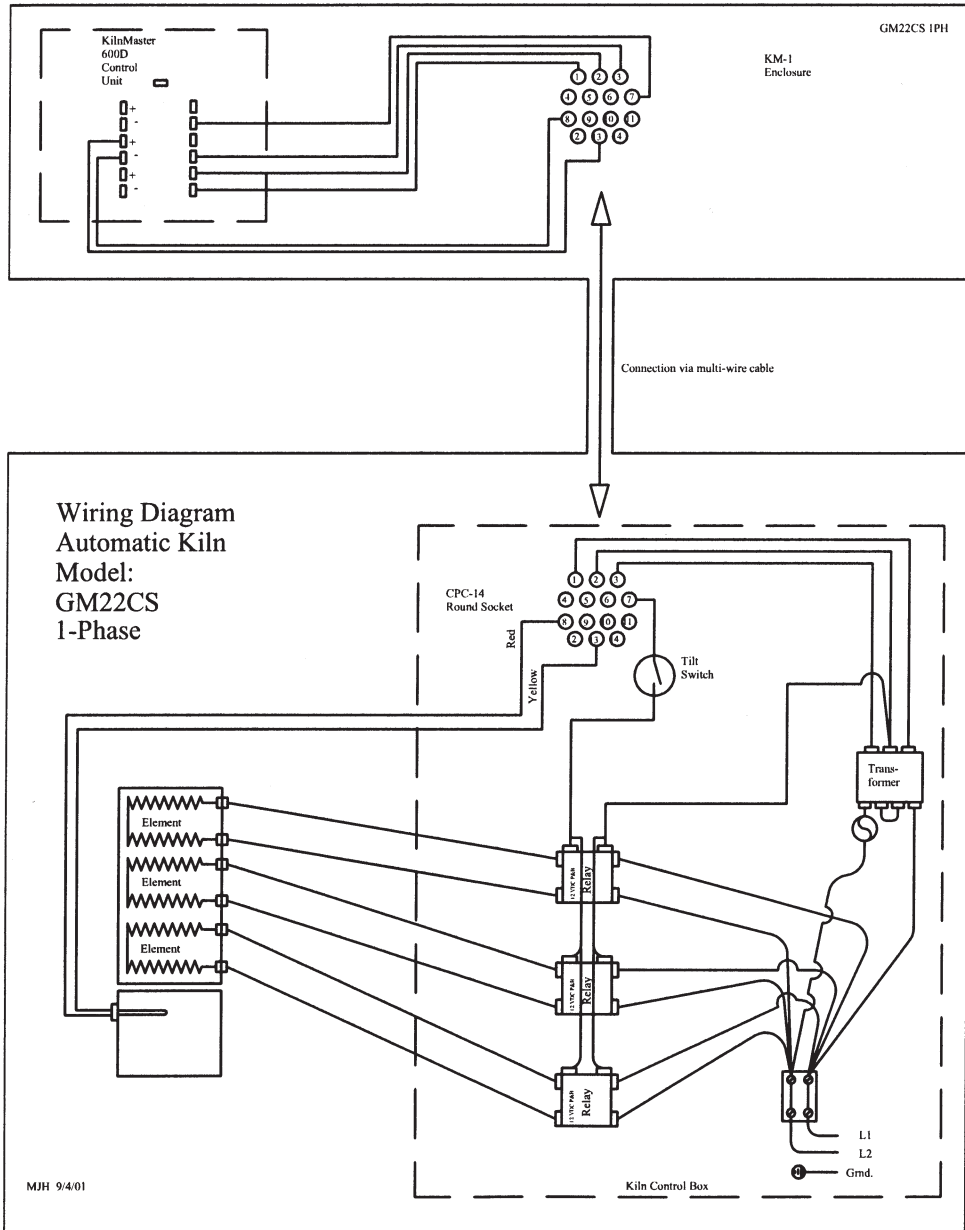

GM22CS 3PH

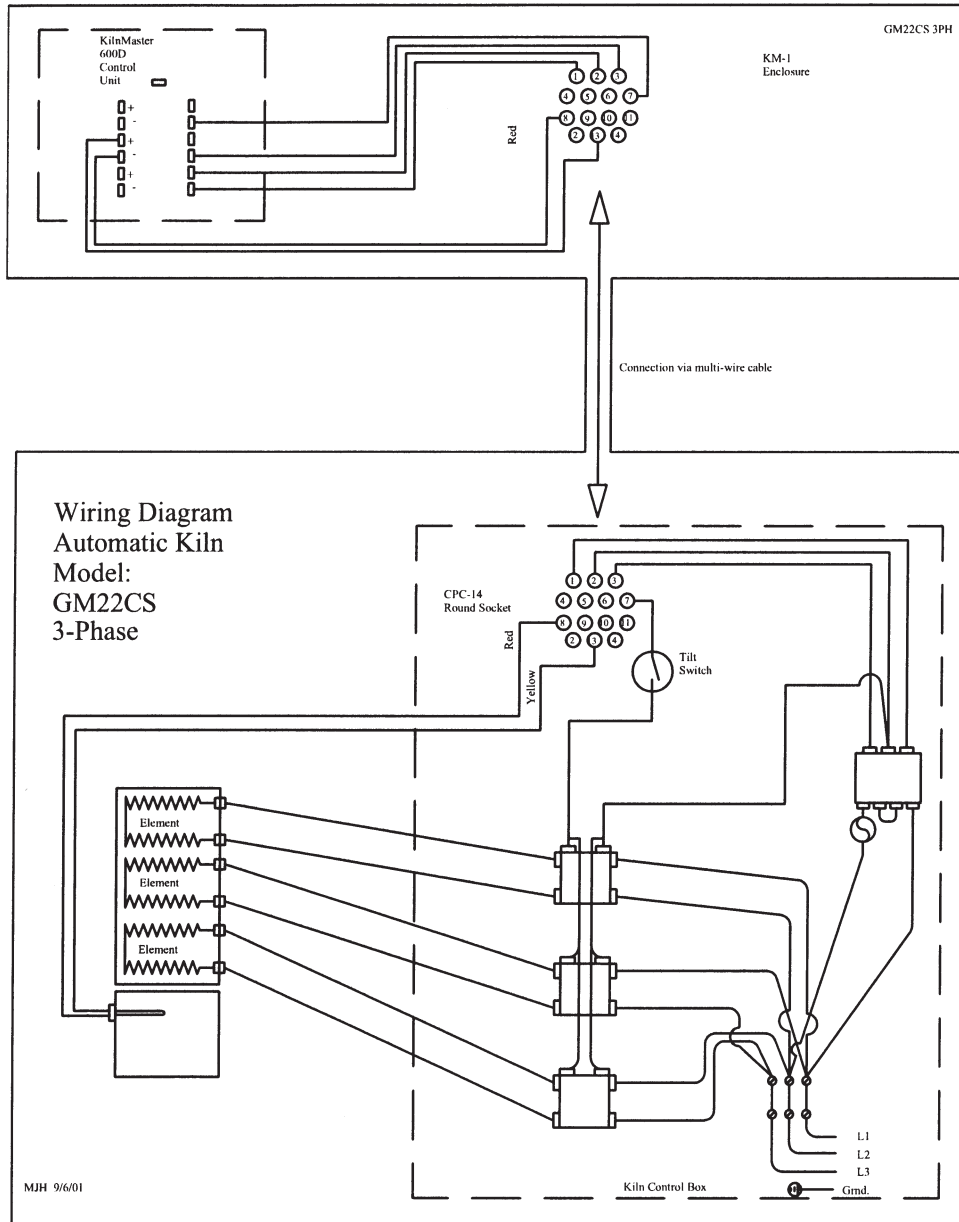

GM10F

Wiring Diagram
Automatic Kiln
Models:
GM10F 1-Phase
Elements in Series

MASTER SWITCH BOX

GM10F

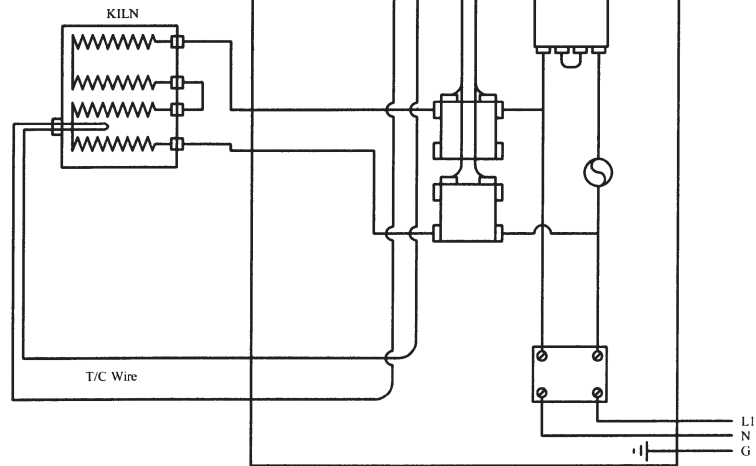

MJH 9/26/01

My Programs

PROGRAM 1	SEG 1	SEG 2	SEG 3	SEG 4	SEG 5	SEG 6	SEG 7	SEG 8
RATE								
TEMP								
HOLD								

PROGRAM 2	SEG 1	SEG 2	SEG 3	SEG 4	SEG 5	SEG 6	SEG 7	SEG 8
RATE								
TEMP								
HOLD								

PROGRAM 3	SEG 1	SEG 2	SEG 3	SEG 4	SEG 5	SEG 6	SEG 7	SEG 8
RATE								
TEMP								
HOLD								

PROGRAM 4	SEG 1	SEG 2	SEG 3	SEG 4	SEG 5	SEG 6	SEG 7	SEG 8
RATE								
TEMP								
HOLD								

PROGRAM 5	SEG 1	SEG 2	SEG 3	SEG 4	SEG 5	SEG 6	SEG 7	SEG 8
RATE								
TEMP								
HOLD								

PROGRAM 6	SEG 1	SEG 2	SEG 3	SEG 4	SEG 5	SEG 6	SEG 7	SEG 8
RATE								
TEMP								
HOLD								

SPARE 1	SEG 1	SEG 2	SEG 3	SEG 4	SEG 5	SEG 6	SEG 7	SEG 8
RATE								
TEMP								
HOLD								

SPARE 2	SEG 1	SEG 2	SEG 3	SEG 4	SEG 5	SEG 6	SEG 7	SEG 8
RATE								
TEMP								
HOLD								

GlassMaster Mounting Template

TOP

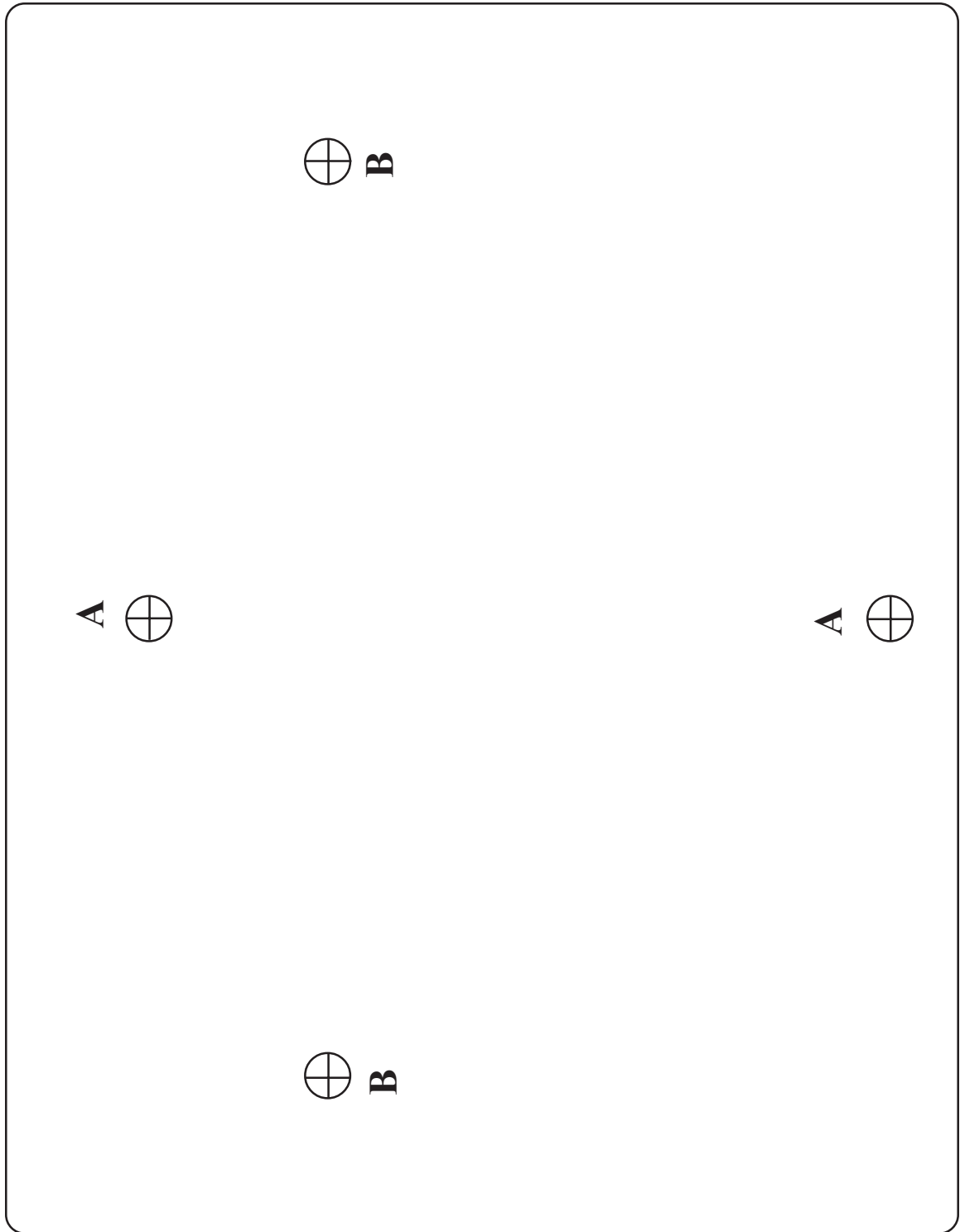

Remove this page with scissors or make a copy if you wish to use the Program Template on the back side of this page. Line up the template so the holes marked "A" are centered on a stud and tape it to the wall. Sink a #12 x 2" wood screw (included in the manual packet) in both holes marked "A", leaving an 1/8" gap between the wall and the screw head. Remove the template and hang the controller over the 2 screw heads. If a stud cannot be located it will be necessary to use four 1/4" x 2" molly bolts in the holes marked "A" and "B".